

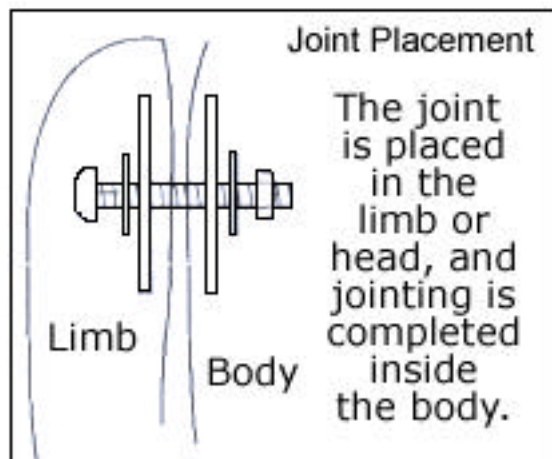

Conker & Hazel 'The Combine Harvesters'

Designed by Ann Thomas and Amanda Davies of Bedspring Bears

September is here and as you get ready to celebrate the Harvest Festival why not take the time make these two beautiful bears. Conker and Hazel are both sewn in rich autumn colours, have big round tummies and look as if they've been stocking up on food before the colder months arrive! They look remarkably similar but Hazel is designed with a wobble head. Once complete they the pair measure 23cm (9") high.

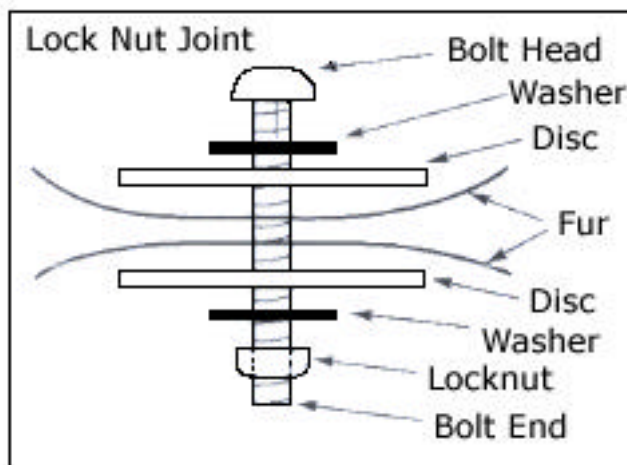
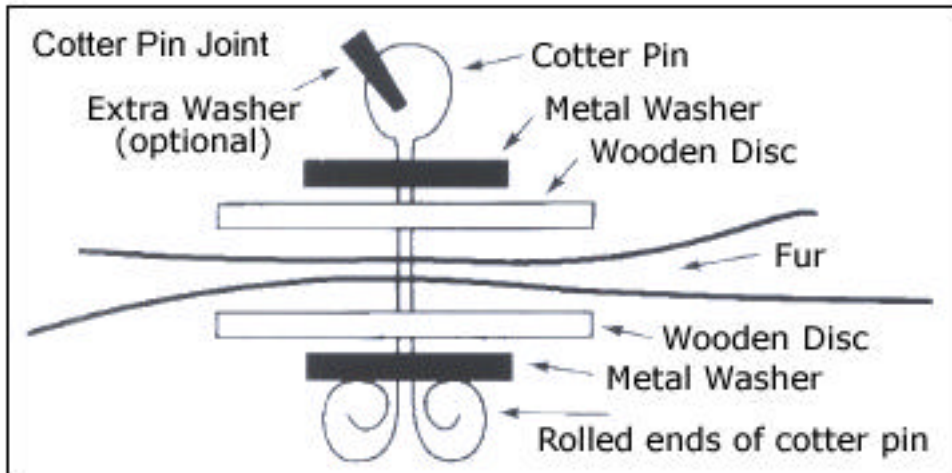

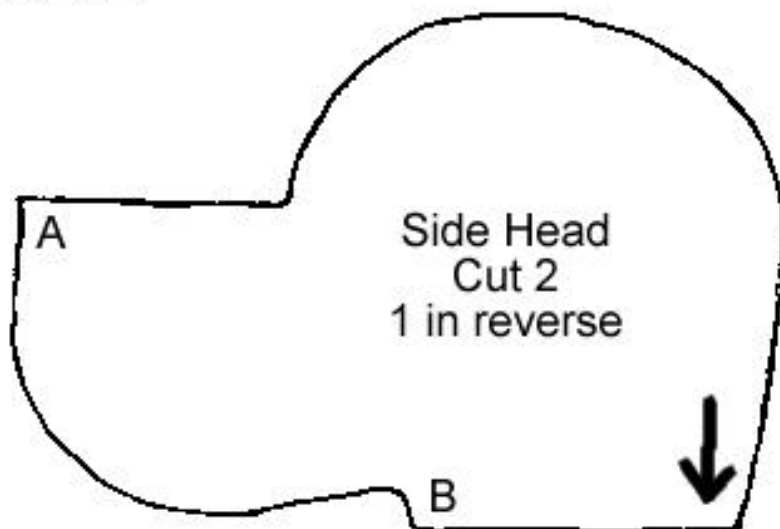
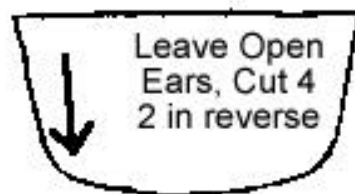
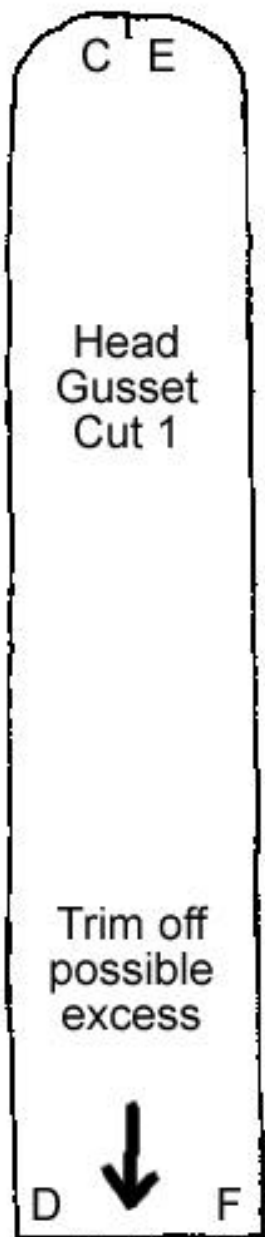
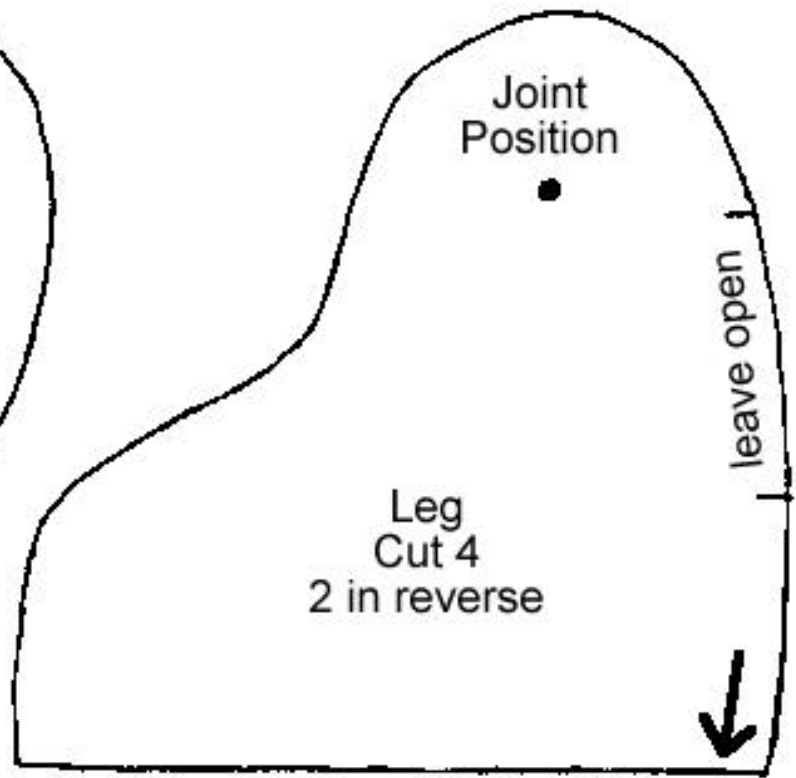
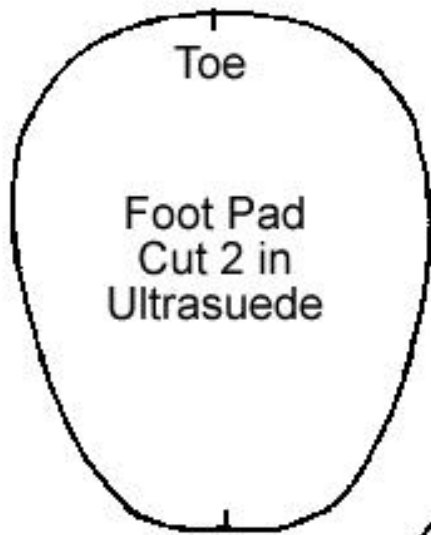

Enlarge this page only by 105% on a photocopier

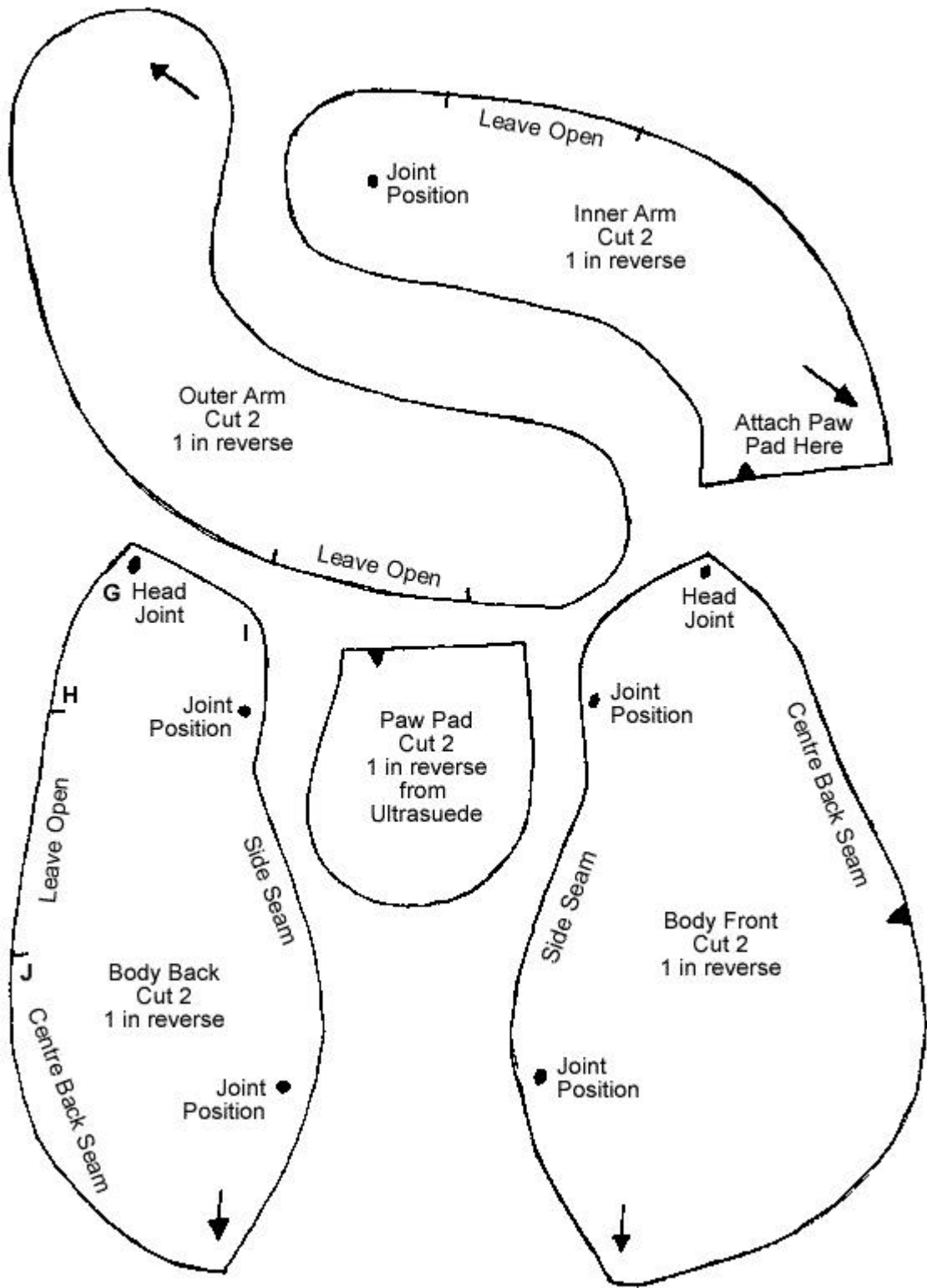

Enlarge this page only by 135% on a photocopier

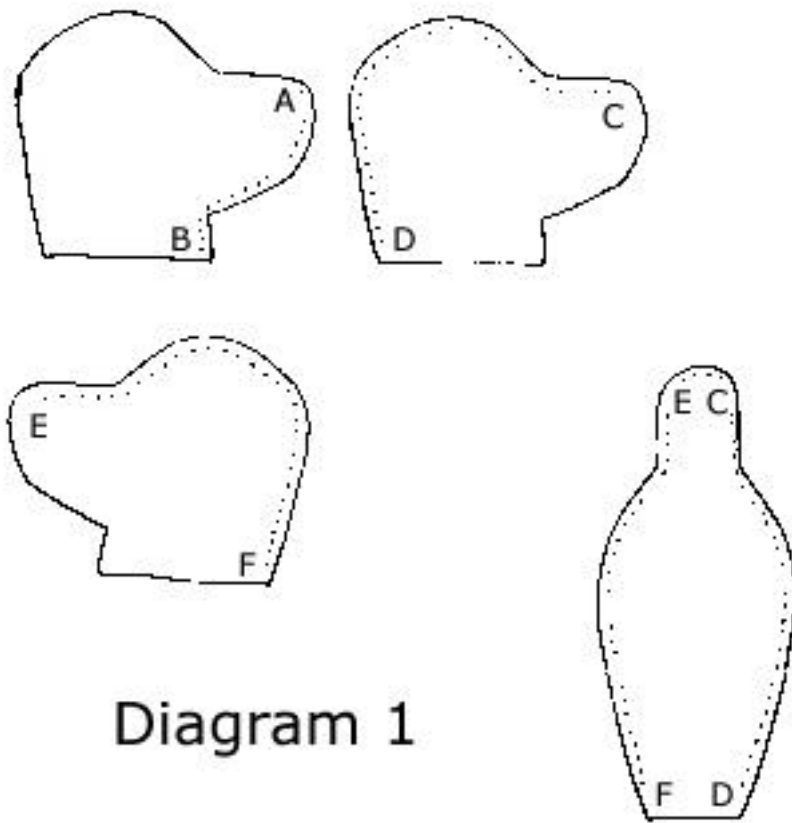

Diagram 1

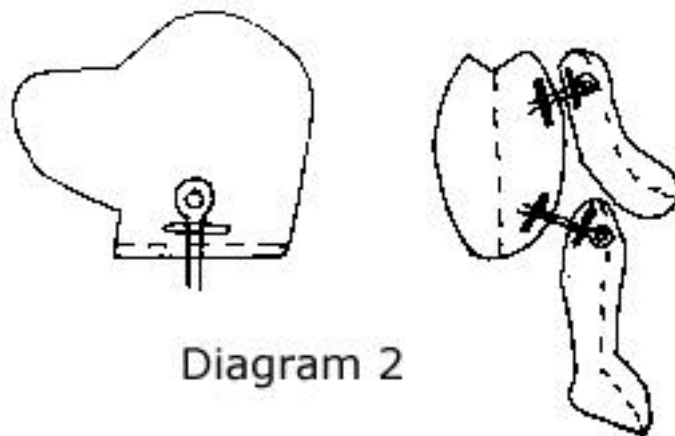
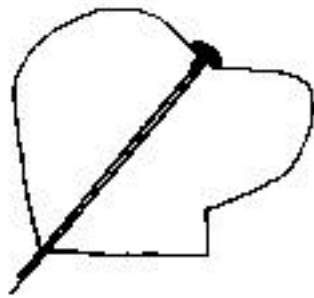
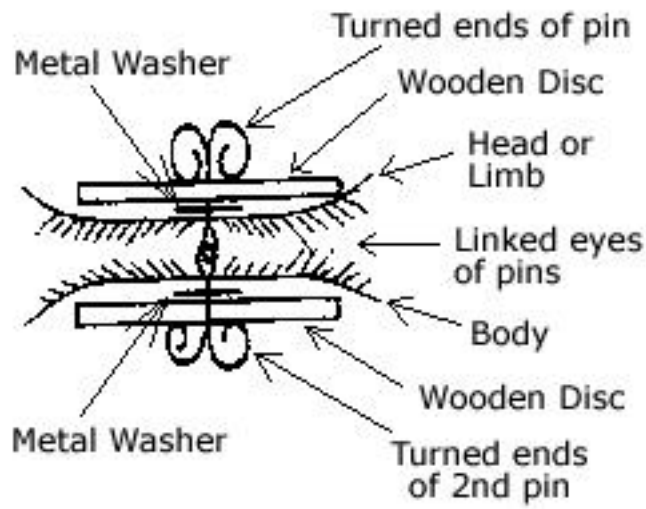

Diagram 2

Diagram 3



Example of nose and mouth pattern

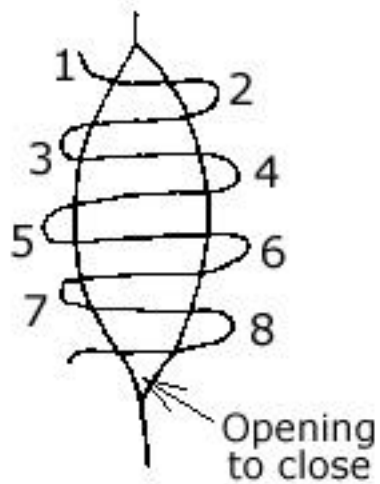

Diagram 4